

GENERAL SPECIFICATIONS FOR SW3000s

Toggles

Rockers

Pushbuttons

Illuminated PB

Programmable

Keylocks

Rotaries

Slides

Tactiles

Tilt

Touch

Indicators

Accessories

Supplement

B Electrical Capacity (Resistive & Inductive Load)**Power Level:** Shown in the following tables**Other Ratings**

Contact Resistance: 10 milliohms maximum
Insulation Resistance: 1,000 megohms minimum @ 500V DC
Dielectric Strength: 2,000V AC minimum for 1 minute minimum
Mechanical Life: 30,000 operations minimum
Electrical Life: 10,000 operations minimum
Angle of Throw (α): Shown on drawings or following tables

Materials & Finishes

Rocker: Urea resin; all rockers are white.
Mounting Frame: Steel with chromate plating over zinc plating
Case Cover/Insulator: Phenolic resin
Case: Melamine phenol
Movable Contactor Plate: Copper with silver plating
Movable & Stationary Contacts: Silver alloy plus copper with silver plating
Terminals: Copper with tin plating

Environmental Data

Operating Temp Range: -10°C through +70°C (+14°F through +158°F)
Sealing: Dustproof cover of silicone rubber on SW3006A, SW3007A, & SW3008A

Installation

Maximum Panel Thickness: Shown with following drawings
Soldering Time & Temperature: Manual Soldering: See Profile A in Supplement section.

Standards & Certifications

- UL: File No. E44145 - Recognized only when ordered with marking on switch.**
 Add "/U" or "/CUL" to end of part number to order UL recognized switch.
 UL or cULus recognition designated beside part numbers on following pages.
 See Supplement section to find UL or cULus rating details.
- CSA: File No. 023535_0_000 - Certified only when ordered with marking on switch.**
 Add "/C" to end of part number to order CSA certified switch.
 CSA certification designated beside part numbers on following pages.
 See Supplement section to find CSA rating details.
- VDE: License No. 119189 - Approved only when ordered with marking on switch.**
 Add "/V" to end of part number to order VDE approved switch.
 SW3006A at 20A @ 125V AC & 10A @ 250V AC

SINGLE POLE WITH SOLDER LUG *

* UL & CSA recognized only when ordered with marking on switch (see General Specs)		Rocker Position/Connected Terminals						Electrical Capacity					
Model	* Approvals		Pole	Down		Center	Up		Resistive		Inductive	$\alpha =$ Angle of Throw	
									AC 125V	AC 250V	DC 30V		AC 125V PF 0.6
SW3001A	✓	✓	SPST	ON	1-3	NONE	OFF	—	15A	6A	15A	10A	24°
SW3002A	✓	✓	SPDT	ON	2-3	NONE	ON	2-1	15A	6A	15A	10A	24°
SW3003A	✓	✓	SPDT	ON	2-3	OFF	ON	2-1	15A	6A	15A	10A	28°

Throw & Schematics: SPST INTERNAL CONNECTION Note: Terminal numbers are actually on the switch.

* Wire harness & cable assemblies offered only in Americas.

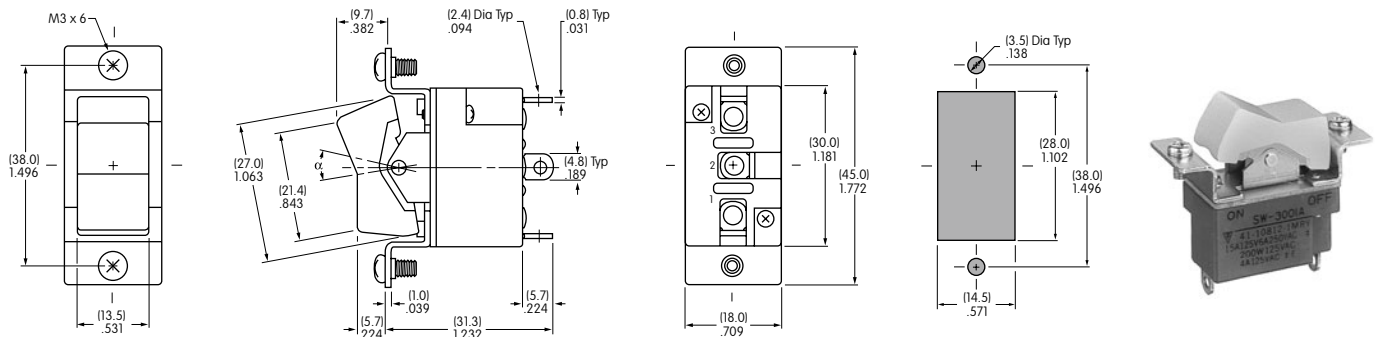

Maximum Effective Panel Thickness:

SW3001A does not have terminal 2. .197" (5.0mm) for SW3001A & SW3002A models; .177" (4.5mm) for SW3003A models **SW3001A**

DOUBLE POLE WITH SOLDER LUG *

* UL, cULus & CSA recognized only when ordered with marking on switch (see General Specs)		Rocker Position/Connected Terminals () = Momentary						Electrical Capacity						
Model	* Approvals			Down		Center	Up		Resistive		Inductive	$\alpha =$ Angle of Throw		
									AC 125V	AC 250V	DC 30V		AC 125V PF 0.6	
SW3006A	✓	✓	✓	DPDT	ON	2-3 5-6	NONE	ON	2-1 5-4	20A	10A	20A	10A	24°
SW3007A	—	—	✓	DPDT	ON	2-3 5-6	OFF	ON	2-1 5-4	15A	6A	15A	10A	28°
SW3008A	—	—	—	DPDT	(ON)	2-3 5-6	OFF	(ON)	2-1 5-4	15A	6A	15A	10A	24°

Throw & Schematic: DPDT Note: Terminal numbers are actually on the switch.

* Wire harness & cable assemblies offered only in Americas.

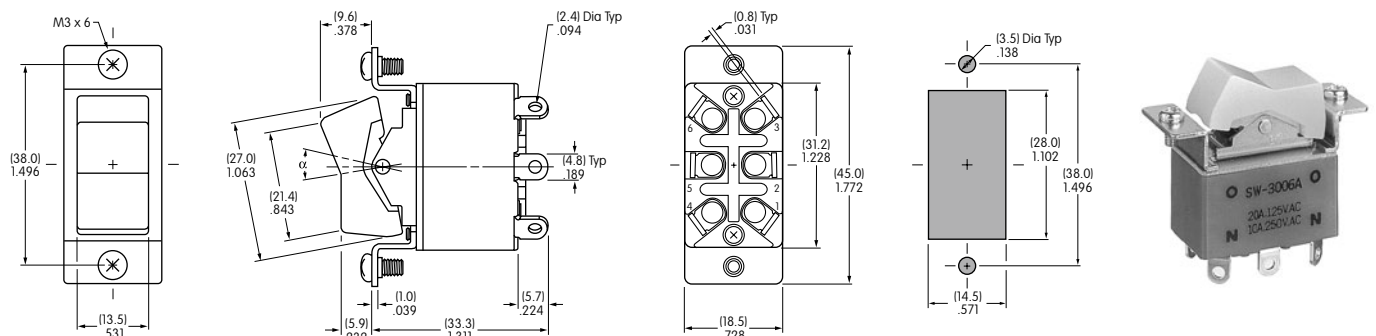

Maximum Effective Panel Thickness:

.197" (5.0mm) for SW3006A & SW3008A models; .177" (4.5mm) for SW3007A models **SW3006A**

GENERAL SPECIFICATIONS FOR SW3800s

Toggle

Rockers

Pushbuttons

Illuminated PB

Programmable

Keylocks

Rotaries

Slides

Tactiles

Tilt

Touch

Indicators

Accessories

Supplement

B Electrical Capacity (Resistive & Inductive Load)

Power Level: Shown in the following tables
 Note: See Supplement section for details of design for inductive DC loads.

Other Ratings

Contact Resistance: 10 milliohms maximum
Insulation Resistance: 1,000 megohms minimum @ 500V DC
Dielectric Strength: 2,000V AC minimum for 1 minute minimum
Mechanical Life: 50,000 operations minimum
Electrical Life: 25,000 operations minimum
Angle of Throw: Shown on following drawings
Nominal Operating Force: 1,800 grams for SW3822
 2,200 grams for SW3823 Off to On
 800 grams for SW3823 On to Off

Materials & Finishes

Rocker: Urea resin; all rockers are white.
Mounting Frame: Steel with chromate plating over zinc plating
Case Cover/Insulator: Phenolic resin
Case: Melamine phenol
Movable Contacts: Copper with silver plating
Stationary Contacts: Silver alloy plus copper with silver plating
Terminals: Brass (terminal screws of brass with nickel plating)

Environmental Data

Operating Temp Range: -10°C through +70°C (+14°F through +158°F)

Standards & Certifications

UL: **File No. E44145 - Recognized only when ordered with marking on switch.**
 Add "/U" or "/CUL" to end of part number to order UL recognized switch.
 UL or cULus recognition designated beside part numbers on following pages.
 See Supplement section to find UL or cULus rating details.

CSA: **File No. 023535_0_000 - Certified only when ordered with marking on switch.**
 Add "/C" to end of part number to order CSA certified switch.
 CSA certification designated beside part numbers on following pages.
 See Supplement section to find CSA rating details.

Wiring for DC400V 10A

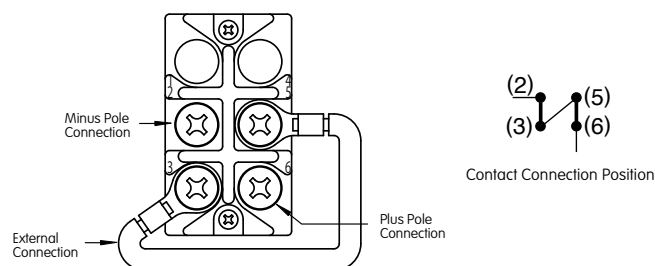

DOUBLE POLE WITH SCREW LUG

Model	*Approvals UL cULus CSA	Pole	Rocker Position/Connected Terminals						Electrical Capacity									
			Down		Center	Up		Resistive				Inductive						
			ON	2-3 5-6	NONE	OFF	—	AC 125V	AC 250V	DC 30V	DC 48V	DC 125V	DC 250V	DC 400V	AC 125V PF 0.6	AC 250V PF 0.6		
SW3821	✓	✓	✓	DPST	ON	2-3 5-6	NONE	OFF	—	30A	30A	30A	—	1A	—	—	30A	15A
SW3822	✓	✓	✓	DPDT	ON	2-3 5-6	NONE	ON	2-1 5-4	30A	30A	30A	—	1A	—	—	30A	15A
SW3823	✓	✓	✓	DPDT	ON	2-3 5-6	OFF	ON	2-1 5-4	30A	30A	30A	—	1A	—	—	30A	15A
SW3821D	✓	✓	✓	DPST	ON	2-3 5-6	NONE	OFF	—	—	—	30A	30A	20A	15A	4A (10A)	—	—
SW3822D	✓	✓	✓	DPDT	ON	2-3 5-6	NONE	ON	2-1 5-4	—	—	30A	30A	20A	15A	4A	—	—
SW3823D	✓	✓	✓	DPDT	ON	2-3 5-6	OFF	ON	2-1 5-4	—	—	30A	30A	15A	—	—	—	—

Throw & Schematics:

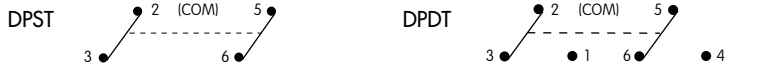

Note: Terminal numbers are actually on the switch.

* UL/CUL & CSA for the following ratings: UL/CUL: 30A @ 30V DC, 15A @ 125V DC; CSA: 30A @ 30V DC, 15A @ 125V DC

* UL, cULus & CSA recognized only when ordered with marking on switch (see General Specs)

() capacity is due to series wiring, see General Specifications page.

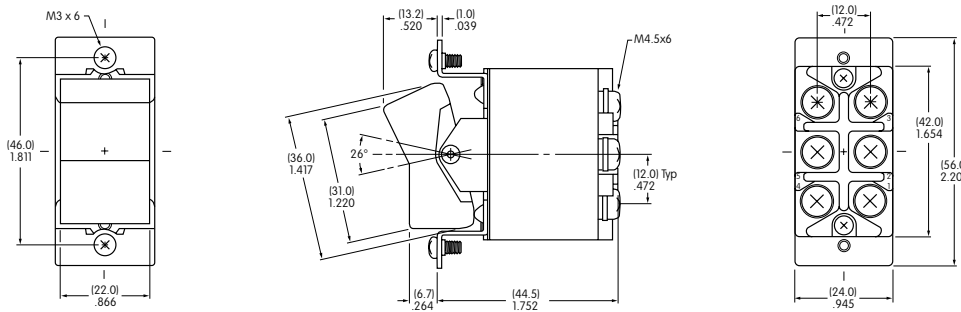

SW3821 & SW3821D do not have terminals 1 & 4.

Maximum Effective Panel Thickness .177" (4.5mm). Panel cutout shown below.

SW3822

THREE POLE WITH SCREW LUG

Model	*Approvals UL cULus CSA	Pole	Rocker Position/Connected Terminals						Electrical Capacity						
			Down		Center	Up		Resistive				Inductive			
			ON	2-3 5-6 8-9	NONE	OFF	—	AC 125V	AC 250V	DC 30V	DC 125V	AC 125V PF 0.6	AC 250V PF 0.6		
SW3831	✓	✓	✓	3PST	ON	2-3 5-6 8-9	NONE	OFF	—	30A	30A	30A	1A	30A	15A
SW3832	✓	✓	✓	3PDT	ON	2-3 5-6 8-9	NONE	ON	2-1 5-4 8-7	30A	30A	30A	1A	30A	15A
SW3833	✓	✓	✓	3PDT	ON	2-3 5-6 8-9	OFF	ON	2-1 5-4 8-7	30A	30A	30A	1A	30A	15A
SW3831D	✓	✓	✓	3PST	ON	2-3 5-6 8-9	NONE	OFF	—	—	—	30A	15A	—	—
SW3832D	✓	✓	✓	3PDT	ON	2-3 5-6 8-9	NONE	ON	2-1 5-4 8-7	—	—	30A	15A	—	—
SW3833D	✓	✓	✓	3PDT	ON	2-3 5-6 8-9	OFF	ON	2-1 5-4 8-7	—	—	30A	15A	—	—

Throw & Schematics:

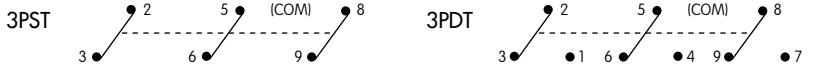

Note: Terminal numbers are actually on the switch.

* UL/CUL & CSA for the following ratings: UL/CUL: 30A @ 30V DC, 15A @ 125V DC; CSA: 30A @ 30V DC, 15A @ 125V DC

* UL, cULus & CSA recognized only when ordered with marking on switch (see General Specs)

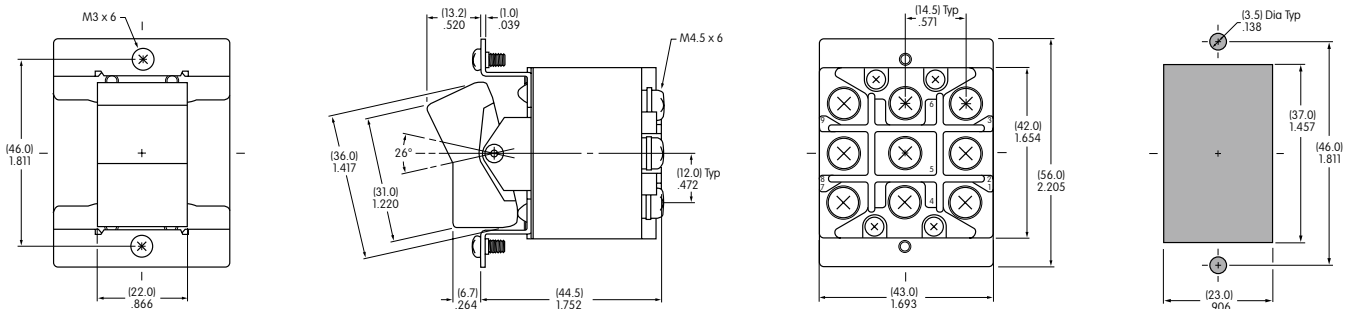

SW3831 & SW3831D do not have terminals 1, 4 & 7.

Maximum Effective Panel Thickness .177" (4.5mm)